



NEW **ELEOS™ LIMB SALVAGE SYSTEM**
Segmental Stem Implants

OPERATIVE SIMPLICITY

The segmental stem portfolio of the ELEOS Limb Salvage System offers contemporary options around stem length, diameter and collar size to meet surgeon preferences and increase intraoperative flexibility. New instrumentation offers a simple solution, addressing clinical challenges around trialing and intraoperative work-flow.

- Bullet tip geometry provides improved accommodation in the natural bow of the femur
- Proportionally scaled collars for improved cortical contact
- Canal filling stems include a broad offering of diameters and lengths optimizing a personalized stem fit
- Instrument platform combines reaming, trialing, and planing for cemented and canal filling stems reducing intraoperative complexity

Cemented Straight CoCr		
Stem Length and Diameter(MM)	Collar Size (MM)	
Ø9 X 100	Ø24	
Ø10 X 100		
Ø11 X 120		
Ø13 X 120	Ø28	
Ø15 X 120		
Ø17 X 120		

Cemented Bowed Ti		
Stem Length and Diameter(MM)	Collar Size (MM)	
Ø11 X 152	Ø28	
Ø13 X 152		
Ø15 X 152		
Ø17 X 152	Ø32	
Ø11 X 200		
Ø13 X 200		
Ø15 X 200	Ø36	
Ø17 X 200		
Ø11 X 255		

Canal Filling Straight Ti		
Stem Length and Diameter(MM)	Collar Size (MM)	
Ø11 X 120	Ø28	
Ø12 X 120		
Ø13 X 120		
Ø14 X 120	Ø32	
Ø15 X 120		
Ø16 X 120		
Ø17 X 120	Ø36	
Ø18 X 120		
Ø19 X 120		
Ø20 X 120		
Ø21 X 120		

Canal Filling Bowed Ti		
Stem Length and Diameter(MM)	Collar Size (MM)	
Ø11 X 152	Ø28	
Ø12 X 152		
Ø13 X 152		
Ø14 X 152	Ø32	
Ø15 X 152		
Ø16 X 152		
Ø17 X 152	Ø36	
Ø18 X 152		
Ø19 X 152		
Ø20 X 152		
Ø21 X 152		

**2019 MSTs
Diamond Level
Sponsor**

NEW ELEOS™ LIMB SALVAGE SYSTEM
Segmental Stem Implants

Instrument platform combines reaming, planing, and trialing in a one-step solution for both cemented and canal filling stems; improving intraoperative workflow and reducing complexity.

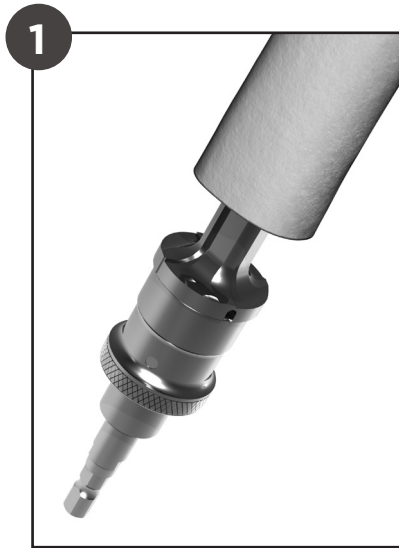
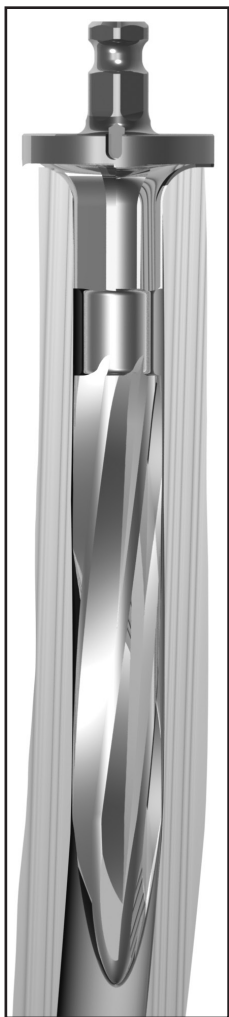

Bone is sequentially reamed for optimal fit.

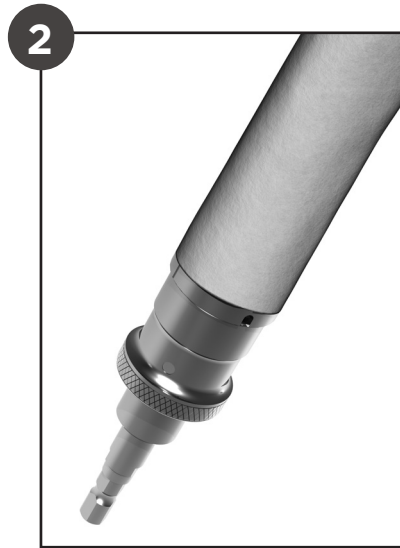

An integral facing planer prepares the resection surface.



The appropriate trial components attach to the Reamer Trials via quick-connect to complete trialing.



**2019 MSTs
Diamond Level
Sponsor**